

### Ordering Informations

WK 09 BK 0 1

Pin  
09=9P  
15=15P  
25=25P  
37=37P

Color  
BK=BLACK  
BL=BLUE  
GY=GRAY  
RD=RED  
YW=YELLOW

Packing  
0=PE bag

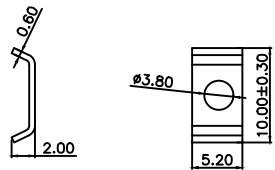
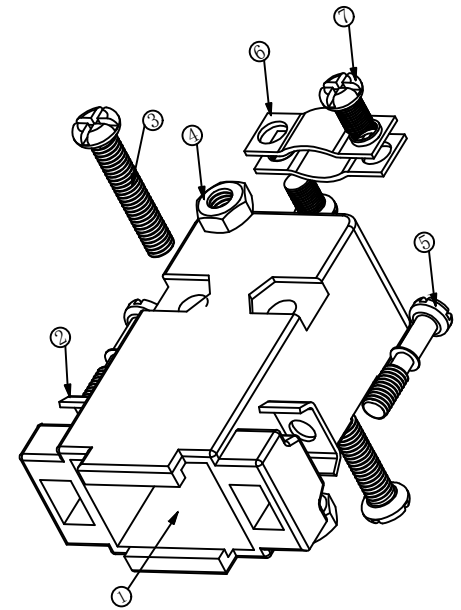

2

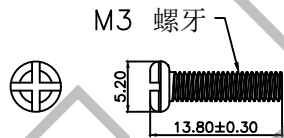

3

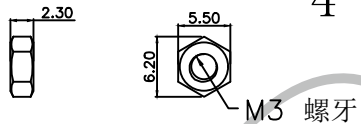

4

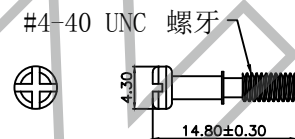

5

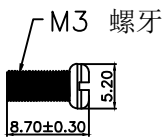

6

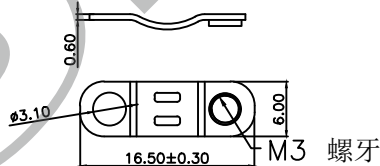

7

序号	品名	规格	用量
1	外壳	DB_9P 上、下外壳 ABS 黑色	各1PCS
2	垫片	垫片 铁 镀镍	2PCS
3	螺丝	M3 L13.8 螺丝 铁 镀镍	2PCS
4	螺母	M3 六角螺母 铁 镀镍	2PCS
5	螺丝	#4-40 UNC 半牙螺丝 铁 镀镍	2PCS
6	螺丝	M3 L8.7 螺丝 铁 镀镍	2PCS
7	线夹	线夹 铁 镀镍 (适用线径5.5~8.0mm)	2PCS

材料:

外壳 : ABS BK (UL94V-0)  
 螺丝 : 铁 镀镍  
 螺母 : 铁 镀镍  
 线夹 : 铁 镀镍  
 垫片 : 铁 镀镍

适配线材外径: 5.5~8.0mm  
 环境参数: -40° C~105° C  
 螺丝扭矩: 0.6N.m

TOLERANCES UNLESS OTHERWISE SPECIFIED

.X ~~~~ ±0.50  
 .XX ~~~~ ±0.30  
 .XXX ~~~~ ±0.20  
 ANGLE ~~~~ ±5°

**苏州金维益电子科技有限公司**  
**SUZHOU JINWEIYI ELECTRONICS & TECH CO;LTD**

品名规格 PART NO.	DB_9P 外壳 ABS 塑胶外壳 袋装				
物料编码 MATERIAL NO.	WK09BK01	制图 DRAWING	Pop Zhang	2022-06-20	单位 UNITS MM
客户料号		图号 DWG NO.	20220620001	审核 CHECKED	比例 SCALE N:1
视图 PROJECTION	第一角	批准 APPROVED	Robert Luo	2022-06-20	图幅 SIZE A4

A1	210303001		21.03.03	Pop Zhang
A0				
版本 REV NO.	变更编号 ECN NO.	描述 DESCRIPTION	变更日期 DATE	变更人 CHANGER